



INSTANT SHELTERS

Tempest Parasol Instructions



Tempest Parasol

TEMPEST HEAVY-DUTY COMMERCIAL PARASOL

The Tempest is manufactured using high quality materials and fabrics and is designed to give you many years of trouble free use and enjoyment. The following information is to inform you on how to operate your Tempest parasol correctly. Please follow these instructions as they are designed to assist operation and prolong the life of the parasol.



VISIT US AT:

SURFTURF.CO.UK

CALL US ON:

01925 819608

Setting Up Parasol

Once you have fixed the base fitting correctly you can erect the parasol by following the below instructions.

To erect the Tempest parasol:

- 1.** Attach the hinged spigot to the base plate or inground fitting with the one smaller stainless steel spigot bolt supplied with your parasol.
- 2.** Use the hinge to lie the spigot horizontally. Using several people to assist, hold the parasol almost horizontal and then slide the parasol over the internal spigot.
- 3.** Secure the parasol to the spigot by inserting the supplied locking bolt through the hole in the mast and spigot, and then tighten up the nut.
- 4.** Lift the parasol up into a vertical position using the hinge. Secure the hinged spigot to the base plate using the four supplied stainless steel spigot bolts and allen key.



Note: Installation is recommended as a three person operation.

Opening the parasol for the first time:

When the parasol is being opened for the first time, ensure the strap and all packaging and wrapping material has been removed. There may be some wrapping material on the canopy arms underneath the fabric canopy - partially open the parasol and get in underneath the fabric canopy to remove all this wrapping before fully opening the parasol.

Important: The parasol support arms are fitted with **PLASTIC SLIDING SPACERS**. The spacers help to keep the arms spread apart when the parasol is closed. This will make it easier to open next time it is used and to prevent the arms getting “stuck” down when trying to open the parasol. When the parasol is packaged for shipping, the spacers are not engaged and are located at the lower end of the support arms. **Before using the parasol for the first time you must engage the spacers into the pre-drilled locking holes by sliding each spacer into position up the parasol arms. A barrell bolt is supplied to secure each spacer into place.**

VISIT US AT:

SURFTURF.CO.UK

CALL US ON:

01925 819608

Operating Parasol

To open the Tempest parasol:

- If opening the parasol for the first time please refer to the section called **“opening the parasol for the first time”** on previous page.
- Remove the strap from the canopy.
Insert the wider handle into the winder hole on the mast and rotate in a clockwise direction.
- Continue winding until the canopy is fully open and taut. Never over wind or force the winder beyond a moderate amount of pressure. **Note:** the winder handle will become a little harder to wind as the parasol nears fully open. This is normal particularly when the acrylic canvas canopy is new.
- The winder handle may be removed if desired as a safety and security feature.

To close the Tempest parasol:

- Insert the winder handle and rotate in an anti-clockwise direction.
- Pull the canopy out from within the arms to safeguard against “pinching” of the canvas within the parasol frame. This is done by pulling the canvas to the outside of the frame using your hand to pull the excess in each of the 8 sections of the frame. Then fold it left over right.
- Put the canopy strap securely around both the mast and canopy frame.
- If you purchased a protective cover bag (optional) then fit over the mast and frame and zip up.

VISIT US AT:

SURFTURF.CO.UK

CALL US ON:

01925 819608

Parts Identification

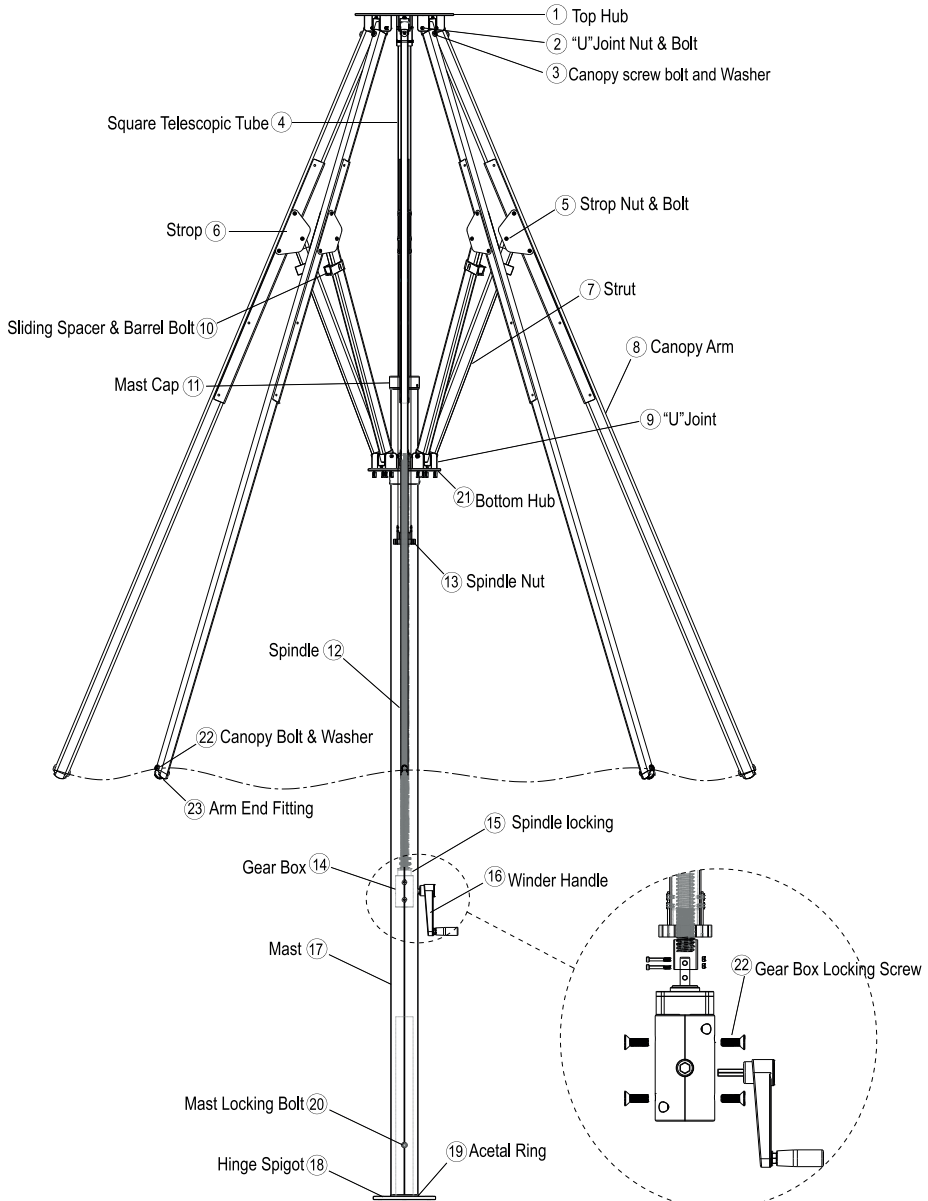

VISIT US AT:





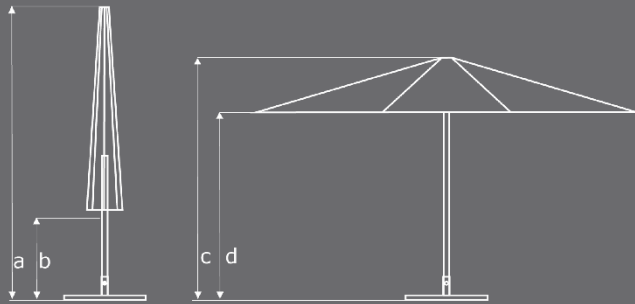

SURFTURF.CO.UK

CALL US ON:

01925 819608

Tempest Parasol Range



Frame Specifications	 3m sq	 4m sq	 5m oct	 5m sq	 3.5m x 2.5m	 3m x 4m
Post (outside diameter x thickness x length (mm))	94 x 3.5 x 2712	94 x 3.5 x 2712	94 x 3.5 x 2712	94 x 3.5 x 3032	94 x 3.5 x 2912	94 x 3.5 x 2912
Long arms (mm)	25 x 50 x 2.2	25 x 50 x 2.2	25 x 50 x 2.2	25 x 50 x 2.2	25 x 50 x 2.2	25 x 50 x 2.2
Dimensions of closed parasol						
a: Height (mm)	4005	4180	4190	4460	4320	4320
b: Closed canopy clearance (mm)	1890	1330	1700	915	1760	1830
Dimensions of open parasol						
c: Height (mm)	2850	3080	3080	3160	3110	3060
d: Canopy edge height (mm)	2310	2320	2320	2320	2430	2330
Weight						
Parasol (unboxed) (kg)	85	95	95	110	90	95
Packaging Dimensions						
Total Length (inc post) (mm)	4200 x 460 x 460	4400 x 460 x 460	4400 x 460 x 460	4600 x 460 x 460	4400 x 460 x 460	4400 x 460 x 460
Weight (boxed parasol) (kg)	100	100	110	115	100	100
Wind Guidance**						
Install wind rating (km/h)	100	90	90	80	90	90

**The above wind speeds are provided as a guide only. Refer to our website and Product Owner Manual provided with the parasol for more information. The product warranty does not cover wind damage regardless of wind speed.

**100KM wind rating applies to 3m Square size only.

VISIT US AT:

SURFTURE.CO.UK

CALL US ON:

01925 819608

Closing Parasol For Long Term Storage

Step One: Stand in front of the parasol and locate the front four fabric panels.

Step Two: Group the four panels and roll together towards the frame.

Step Three: Fold the remaining panels over the rolled panels one by one, alternating from left to right until all panels are neatly folded.

Step Four: Secure the folded panels in place with the velcro strap by wrapping it around the parasol tightly. The parasol is now ready for long term storage.



VISIT US AT:

CALL US ON:

SURFTURF.CO.UK

01925 819608

Parasol Care

You will get maximum benefit from your parasol when you use it in accordance with our instructions and in the weather conditions for which it was designed.

General Information:

- Do not leave the parasol open when unattended, particularly in windy conditions.
- The parasol should be closed and securely strapped in strong winds and adverse weather conditions.
- Always secure your parasol to an appropriate footing/base.
- Any modifications to your parasol, except those made by Surf & Turf Instant Shelter Ltd. may invalidate the warranty.
- Make sure the parasol is dry and clean prior to storing away for extended periods of time to prevent mould from developing.
- Be careful when closing the parasol to ensure that the canopy does not get caught or "pinched" by the parasol arms. This is particularly important before storing the parasol away for extended periods of time or if the parasol is to be laid horizontally for storage. Damage to the fabric caused by "pinching" is not covered by warranty.

Maintenance Instructions For Your Tempest Parasol:

- In coastal or metropolitan environments it is beneficial to wash off any dirt, pollen sand salt residue from the parasol frame and fabric using a hose or soft bristle brush.
- Periodic spraying of silicon spray into the gear box through the winder hole will assist operation and prolong the life of the winder unit.
- If you have purchased a protective cover bag it is advisable to use it if the parasol is not to be used for some time. The parasol must be dry before being packed in a cover bag.
- Inspect the installation fitting/base on a regular basis and tighten as necessary.
- Periodically check all the connecting brackets and joints of the parasol to ensure that all bolts/fittings are tight and secure. Tighten any bolts as required.

VISIT US AT:

SURFTURF.CO.UK

CALL US ON:

01925 819608

Recasens 100% Solution-Dyed Acrylic Canvas Fabric

- Surf & Turf uses the finest marine grade solution-dyed acrylic canvas fabric manufactured by S.A. Recasens in Spain. This premium outdoor fabric has the best available colour fastness rating of 7.8 out of 8.
- Recasens fabrics also has the highest possible UV protection rating of UPF 80 according to the European UV standard 801, cutting out the maximum amount of harmful UV light for excellent sun protection.

HOW TO CLEAN YOUR OUTDOOR PARASOL FABRIC

- Recasens acrylic canvas fabric is water and mould repellent and will last a very long time if maintained well. However, over time, the accumulation of dust, pollution particles, organic plant matter, pollen and general dirt can embed itself into the fabric and shorten the life of it.
- It is a good idea to periodically give your parasol fabric a light brush down with a soft bristled brush/broom and water from a garden hose. This will help to dislodge and remove loose dust and dirt that has settled on the fabric before it can embed itself deeply. Although mould will not grow directly on clean acrylic canvas, as dirt and organic matter embeds itself into the fabric the mould will be able to grow on the embedded dirt and organic matter, so it is best to remove dirt early.

How To Clean Light Dirt And Marks From Your Outdoor Parasol Fabric:

- Depending on how often you use your parasol, you may eventually need to give it a more thorough wash to remove any embedded dirt or early signs of mould growth. To do this you will need to mix warm water and sugar soap in a bucket. Use a soft bristled brush (or a long broom) to generously work this soapy water into a lather over the parasol fabric. Focus mostly on the areas with the most dirt or stains, then allow the soapy water to soak into the parasol fabric.
- Once you are finished soaking the parasol fabric, rinse it thoroughly with a hose until all soap residue is removed, and then air dry the fabric.
- Once you have finished soaking the parasol fabric, rinse it thoroughly with a hose until all the soap residue is removed, and then air dry the fabric.

Parasol Care

How To Remove Heavy Dirt Or Mould From Your Outdoor Parasol Acrylic Canvas Fabric:

- If you have heavy dirt or mould growth in your acrylic canvas fabric and the instructions above have not removed it, you may need to repeat the instructions again, but add between half and one cup of bleach to the bucket of soapy water. The acrylic canvas fabric used by Instashade should not fade or lose colour when using bleach (diluted with water) when cleaning. Feel free to test the bleach mixture on the canopy strap first to check that there is no colour loss.
- The best way to remove heavy dirt and mould is to remove the canopy from the parasol and soak it in warm water with something like bleach or “Vanish Oxi Action”. You might need to change the water and repeat this process until all the dirt or stains are removed. It is then essential that the fabric is thoroughly rinsed with water to remove any cleaning product. A good way to do this is to put the fabric through a gentle machine wash with cold water and washing detergent. Once this is done, put the parasol fabric back on to the parasol frame wet and then allow to air dry..

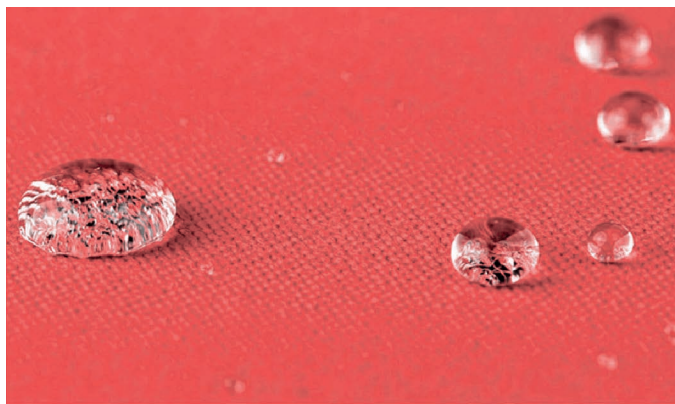

VISIT US AT:

SURFTURF.CO.UK

CALL US ON:

01925 819608

PARASOL BASE CARE

Do not let dirt build up on the bases. Cleaning with mild soap and water, and seasonal touch-up of any scratches, chips or occasional rust seepage from crevices or hidden, unfinished surfaces inherent in some designs is all that is required. Never leave bases standing in water. To keep your bases looking their best, you may wish to store them when not in use for any extended period of time.

SUMMARY

Light Cleaning

- Brush off dust and dirt with a soft brush. NEVER brush with stiff brushes since this can damage the fabric finish.
- Spray the parasol with clean water. If a hose is used, avoid high pressure.
- Prepare a solution of sugar soap in warm water (no more than 30°C) and apply it to the fabric and stitching.
- Scrub with a soft brush, allowing the solution to penetrate the fabric.
- Rinse with water to remove all traces of soap.
- Let air dry and do not close the parasol until the canvas is completely dry.

Deep Cleaning

- Brush off dust and dirt with a soft brush. NEVER brush with stiff brushes since this can damage the fabric finish.
- Remove the roof fabric from the parasol.
- Prepare a solution of something like bleach or "Vanish Oxi Action" in warm water (no more than 30°C).
- Scrub with a soft brush, allowing the solution to penetrate the fabric.
- You may need to change the water and repeat if necessary.
- Ensure that all the product is rinsed from the fabric put on a gentle machine was on a Gentle Machine wash with cold water and laundry detergent.
- Let air dry and do not close the parasol until the canvas is completely dry.

VISIT US AT:

SURFTURF.CO.UK

CALL US ON:

01925 819608

Installation

Your Tempest parasol comes fully assembled in the box. Before you can erect and set up your Tempest parasol you will need to install the required base fitting which is either a base plate or inground fitting. Prior to fixing the base plate or inground fitting please read the following important information

Alignment of the base fitting to face the parasol in the correct direction

There are 4 x threaded holes in the centre area of the 400mm diameter base plate and on the top of the inground fitting sleeve plate and these are called the threaded spigot holes.

Before installing your base plate or inground fitting, draw an imaginary straight line through two sets of threaded spigot holes. This will be the direction of one of the flat sides of your parasol. Use these imaginary lines to square off your base fitting installation. This is of particular relevance when installing square shape parasol and not as important with an octagonal parasol.



Once you have erected the parasol if you find it is still not completely squared off to your area, you can always turn the parasol 90° degrees on the spigot and re-drill a new spigot hole through the street spigot inside the parasol (a good quality 12mm drill bit and high powered drill will be required).

VISIT US AT:

SURFTURF.CO.UK

CALL US ON:

01925 819608

Base Plate Installation

There are 2 ways to install your base plate depending what you are fixing to. Select which is applicable for your situation.

1. Fixing the base plate to a timber deck:

If you wish to install your Tempest parasol onto a timber deck then the following installation method should be adhered to. **Your base plate must be bolted to the frame of the deck and not only to the deck planking.** You need to fasten 2 or 3 “nogs” or “braces” between the deck joists or bearers that form the structural frame of the deck. The nogs need to cover the area under the base plate. They must be secured hard up under the deck planking and between the deck bearers and fastened to the deck frame with fasteners. The fasteners may be large galvanised nails, Z nails, builders brackets or similar. The base plate should now be set in the required position and bolted through the deck planking and the fixed braces by using at least 12mm countersunk 150mm stainless steel bolts and nylocks with a large washer on the underside.

It is recommended to seek the advice of a builder or engineer especially when installing larger 4m or 5m size Tempest parasols onto a deck or when the parasol will be in a high wind zone.

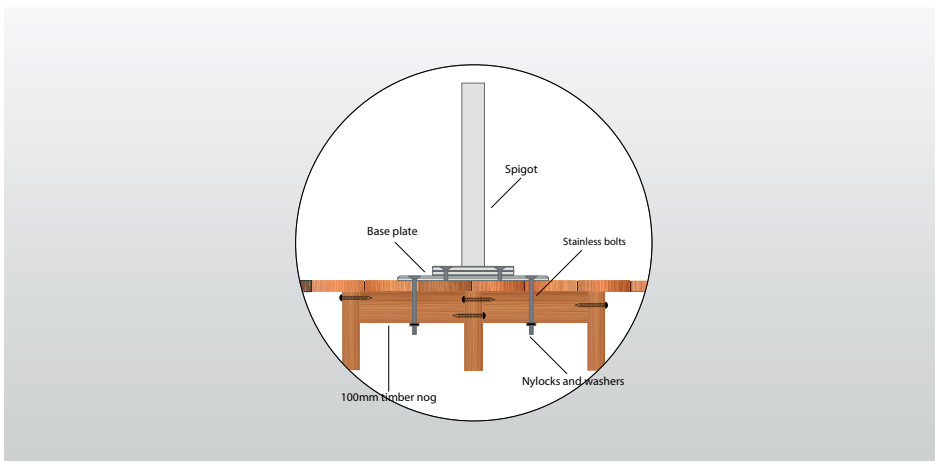

VISIT US AT:

CALL US ON:

SURFTURF.CO.UK

01925 819608

Base Plate Installation

2. Fixing the base plate to a concrete slab:

When installing your parasol on a concrete surface fix the base plate to the concrete using six galvanised or stainless concrete screw fixings. The concrete slab should be at least 150mm thick. The fixings used should be at least 75mm long (100mm recommended) and 10mm in diameter.

Important: Prior to fixing the base plate to the deck or concrete slab please ensure you have read the paragraph section "Alignment of the base fitting..." On page 3.

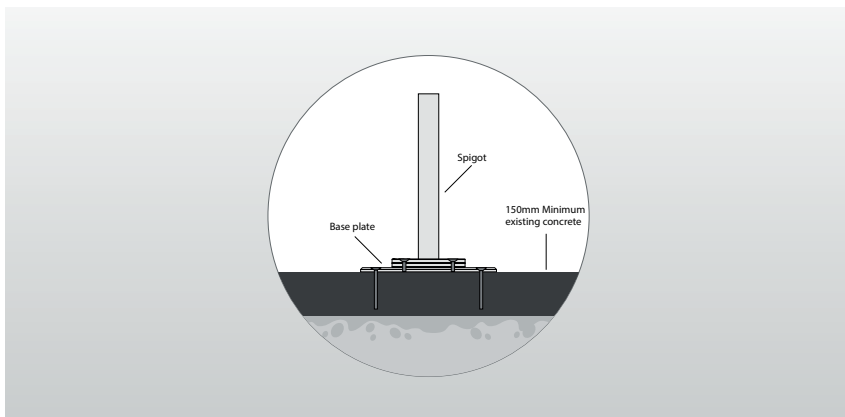

Inground Installation

Fixing into lawn, soil or patio:

When installation is required in soil or lawn then an inground fitting must be used. This is a galvanised steel fitting which must be concreted into position. Terrain differs from thick clay to sand or fine soil so a different sized hole must be prepared and a different volume of concrete used to suit. As a guide only a hole 500mm x 500mm x 700mm deep is a minimum requirement for heavy clay soil terrain. Even then a post hole borer can be used to deepen the centre of the footing. When pouring the concrete it is advisable to drop a few lengths of reinforcing steel bar into the hole to prevent the concrete from cracking. Remember that depth of hole is better than width and it is much easier to make the hole over-size than to try to re-stabilise the inground fitting should it start to move over time. Pavers may need to be removed to facilitate this inground fitting and then cut to suit when replaced.

When setting the inground fitting in the concrete you must ensure the fitting is 100% level. Allow adequate time for the concrete to cure before installing the parasol. This depends on the cure time of the concrete but is normally about 7 days.

IMPORTANT: Prior to install the inground please ensure you have read the paragraph section "Alignment of the base fitting..." On Page 3.

Tip: To ensure that concrete does not come up the threaded spigot holes in the inground fitting it is advisable to put the supplied spigot bolts into the required threaded spigot holes (if they do not already have a threaded guard in the hole). It's also recommended to apply some tape over the underside of the holes as a precaution.

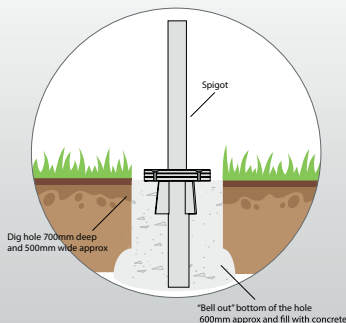

VISIT US AT:

CALL US ON:

SURFTURF.CO.UK

01925 819608

Cross Base Installation

Step 1.

Firstly line up the four large counter sunk holes on the base plate with the screw holes on the cross base.

Step 2.

Using the large counter sunk bolts, secure the base plate to the cross base.

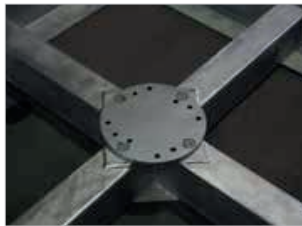

Step 3.

Remove six grub screws, these should line up with the four external holes on the spigot, and two internal holes.

Step 4.

Secure the bottom plate of the hinged spigot to the base plate using the 20mm counter sunk screws.



Step 5.

Slide parasol mase onto spigot. Lift into position and secure the top plate of the hinged spigot to the base plate using the remaining four counter sunk bolts.



VISIT US AT:

CALL US ON:

SURFTURF.CO.UK

01925 819608

Tempest Parasol

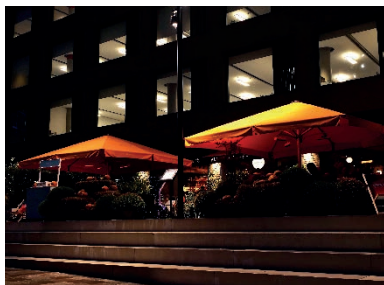

VISIT US AT:
SURFTURF.CO.UK

CALL US ON:
01925 819608



INSTANT SHELTERS

Surf & Turf Instant Shelters Ltd

Unit 7 Tatton Court, Kingsland Grange, Warrington, Cheshire WA1 4RR

01925 819608 info@surfturf.co.uk